

Sonesse Ultra 30 WireFree RTS Li-ion Motor

Motorization

The Sonesse Ultra 30 WireFree RTS motor has a built-in, rechargeable lithium-ion battery to minimize maintenance, and eliminate the need to install and replace batteries.

SPECIFICATIONS

Minimum shade width **35"**
 Maximum shade width **120"**
 Maximum weight **11 lbs**
 Motor connection **Built-in Rechargeable Battery**
 Power connector **10" Motor Charging Cable Plug**
 Control options
Wireless Wall Switch
Wireless Remote
Universal Interface
Timer
Sun Sensor
mylink™ RTS smartphone and tablet interface and voice controlled with Amazon Alexa

TECHNICAL FEATURES

Voltage supply **12V DC**
 Index protection rating **IP 20**
 Limit switch type **Electronic**
 Temperature working range **32°F to 140°F (0°C to 60°C)**
 Insulation class **Class III**
 Antenna **Must not come in contact with metal**
May need to be repositioned for optimal range

PERFORMANCE

Voltage **12V DC**
 Torque **2 Nm**
 Speed **10-28 rpm (programmable)**
 Sound Level **38 dBA**
 Low Battery Indicator **LED**
 Radio Frequency **433.42 MHz**
 Radio frequency control range **65ft**

NOTE

- Regulated power supply required to connect charger
- Charging takes approximately 2-3 hours
- Regularly scheduled battery re-charging is recommended annually for optimum performance
- Frequency of charging required will vary by usage and size/weight of shade

mylink™ is a registered trademark of Somfy.

DIAGRAM

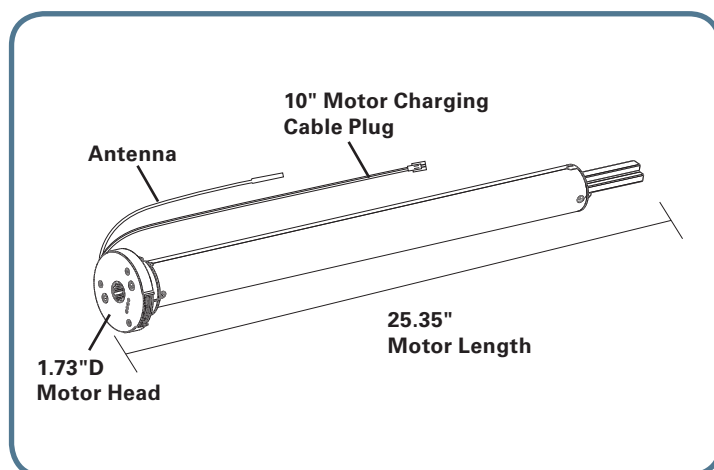

FOR OPTIMAL PERFORMANCE, THE ANTENNA WIRE MUST BE EXPOSED AND NOT COME IN CONTACT WITH METAL SURFACES. DO NOT CUT ANTENNA WIRE. REPOSITION AS NECESSARY.

PLUG-IN CHARGER

- Eliminates the need to install or replace batteries
- Connect charger to the charging cable that is attached to the motor, then plug into a regulated power supply
- Charger comes standard with a 6ft cable
- 8ft cable extension for charger available upon request

