

Duette® Honeycomb Shades

SkyLift™ Manual

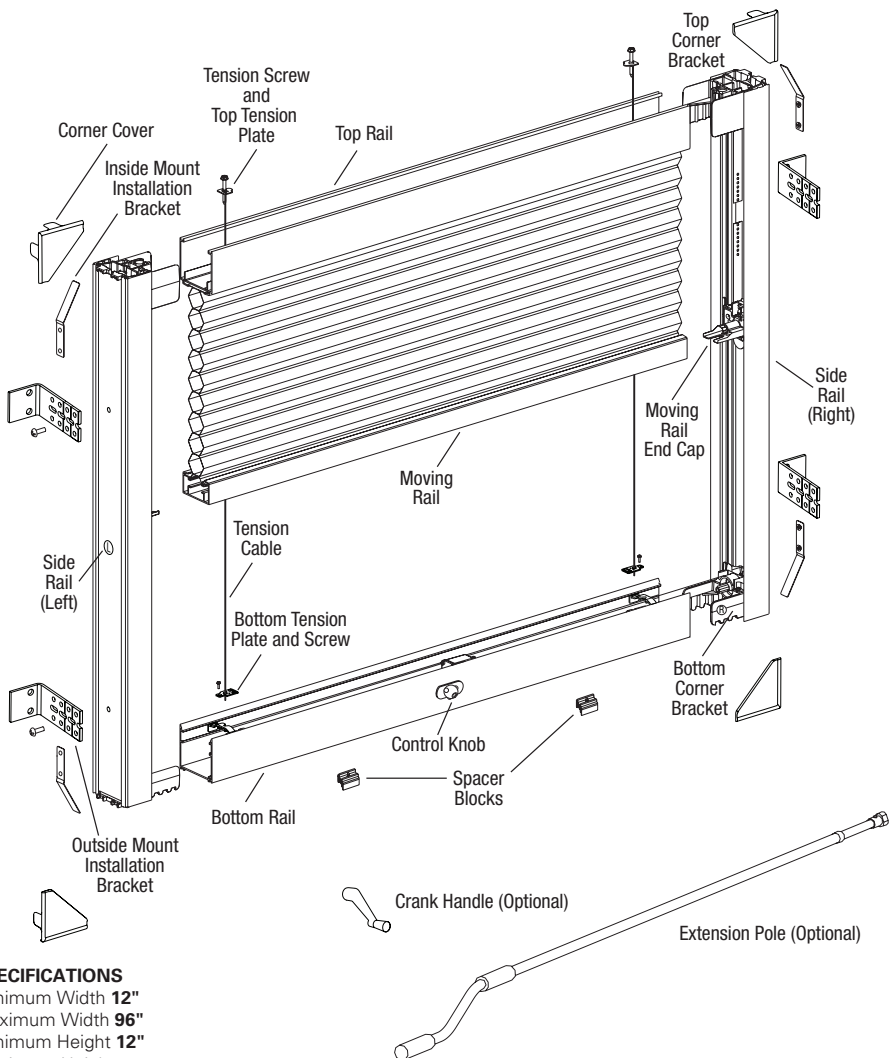

SPECIFICATIONS

Minimum Width **12"**

Maximum Width **96"**

Minimum Height **12"**

Maximum Height

Varies based on width of shade

Extension Pole Sizes **6' or 10'**

Hardware Colors

Aspen White, Bronze, Gardenia White

MOUNTING REQUIREMENTS

Inside Mount **2-1/2" depth minimum**

Outside Mount Surface Height **1-1/4" minimum**

Recommended width overlap per side **2"**

CRANK HANDLE (must be specified)

CLEARANCE NEEDED

Below Bottom Rail **1-1/2" Height**

Depth in Front of Bottom Rail **1" Depth**

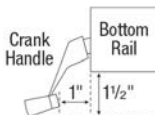

Hunter Douglas Hospitality's products vary in weight and require specific mounting points. Suitable mounting surface and structural support where needed is to be provided by others.

HunterDouglas 
Hospitality

MOUNTING

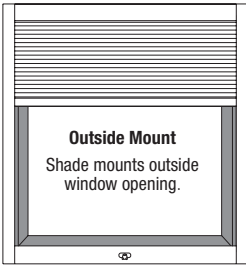
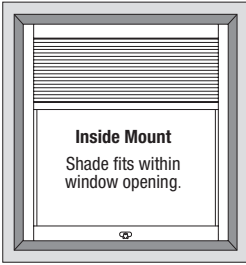

HARDWARE COLORS

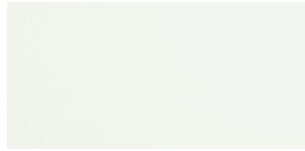

Aspen White



Gardenia White

Bronze (pictured to the left)

Images are for reference only.

For actual color, please

send sample request to

HDHsamples@hunterdouglas.com

OPERATION

Operate the Shade

■ **If you have an extension pole:** Set the extension pole to the correct length, if necessary.

- Locate the pole lock and press the lock in firmly.

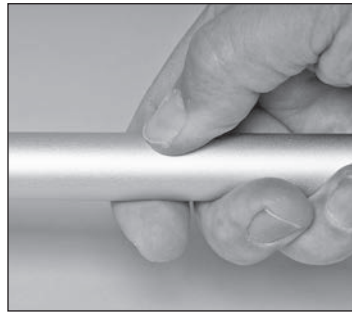
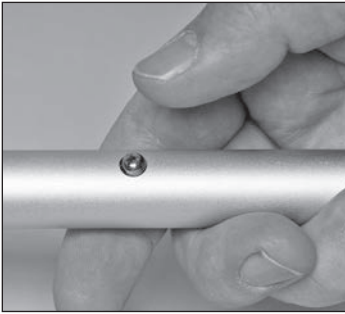

- Slide the pole extension until it locks in place at the correct length.

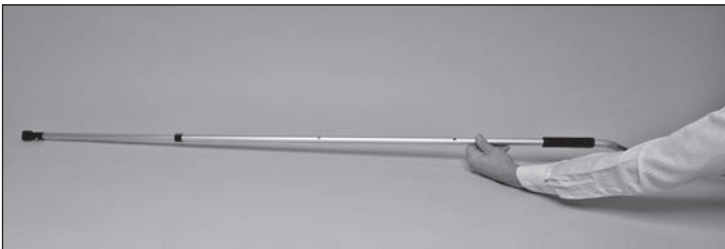

To Lower the Shade

- Rotate the crank handle or the extension pole counterclockwise to lower the shade.

**To Raise the Shade**

- Rotate the crank handle or the extension pole clockwise to raise the shade.

